

Contents lists available at [ScienceDirect](https://www.sciencedirect.com)

Learning, Culture and Social Interaction

journal homepage: www.elsevier.com/locate/lcsi

Full length article

Part 3: The study on the development of human mental activity Lecture 10. The development of mental actions and the orienting basis of actions



Irina Engeness*

Faculty of Education, Østfold University College, Norway

Today we begin the study of the formation of mental functions. As long as the mobility of animals creates unique and non-repetitive situations it is impossible to manage an action without creating an image of this action. As you know, any action of an animal or a human consists of two main parts: orienting and executive. These two aspects are important because normally when we are talking about an action we have in mind its executive part only. Of course an action cannot exist without its executive part. What can exist without an executive part - is only a plan of actions, a scheme of the future. However, we usually have in mind only the executive part of an action and forget about the fact that every performance critically depends on the orientation of a person or a learner while performing this action, we simply forget about the orienting part. In fact, we should regard orienting as an aspect of managing the action. As you will see later, some important aspects of the formation of individual actions, the success of their application and generally their significance in the life of an individual depends on the quality of the orienting part of the action. It is the orienting part and not an action itself that constitutes the focus of psychology and therefore, in what follows we will consider the focus of psychology as the orienting part of an action.

In examining orienting, one can distinguish several systems, but above all there are two large systems - a motivational system and an operating system. The operating system comprises the elements of the action. We are not going to introduce the motivational system now, not because it is not worth doing so, but because it will be presented later. Now we will focus on the operating system as elements in the orientation of the action. In the operating system we can distinguish at least *four main components*.

The first component - is constructing an image of the present situation, describing the location of the things we will need to act with. It may not necessarily be a totally new situation, but a situation that needs to be clarified or, at least, confirmed that it is the same situation learners have been exposed to before. We should either confirm this, or add something, or describe in detail a totally new situation. So, the first component is building or updating the image of the present situation.

The second component of the operating aspect of orientation is clarification of the potential of the individual components of the present situation for the interests of the acting subject - a learner. This clarification is the primary purpose, because there are other functions of these components: as a tool to perform an action or create additional conditions for the action. However, it is important to identify the potential of the individual components for the primary, the actual, need of the learner. Alexei Leontiev describes this need in the lofty term of 'a personal meaning'. Of course, this is correct in relation to a person, although it is not always so lofty. In general, we are talking about the significance of the individual components for the needs of the learner.

The third component is planning future actions. Animals do not create plans, but they identify the way to reach the desired objective, or, the opposite, the way to retreat from the objective if it is dangerous or undesirable.

Finally, *the fourth component* is very complicated: it is the further orientation of the action during its execution. We call it: facilitation of the action in the course of its execution. This facilitation comprises two major parts: a) actual control over the process of execution of the action; and b) correction of the observed deviations.

* Faculty of Education, Østfold University College, B R A veien 4, 1757 NO Halden, Norway.

E-mail address: Irina.engeness@hiof.no.

<https://doi.org/10.1016/j.lcsi.2020.100430>

Available online 16 June 2020

2210-6561/ © 2020 The Author. Published by Elsevier Ltd.

As you can imagine, each of these four major components of the scheme¹ that comprises the orienting part of an action and especially the last component, can grow into a large independent field of study. For example, the construction of the image of the present situation, in fact, can become a form of a cognitive activity and so present a separate scientific area of study with all its ramifications.

However, I would like to warn about the following: the fact that the process of the development of cognition can grow into an independent area of study, does not mean that at the beginning of ontogenesis, we can say that a baby is able to conduct a very small cognitive activity on a reduced scale. A cognitive activity, being a particular type of human activity, is qualitatively different from the type of activity a baby can perform. The orienting activity of a baby is closely related to and is marked by its immediate practical implementation. So, the difference between the cognition of a baby and an adult is qualitative rather than always easily measurable.

Similarly, an understanding of the potential of the elements in the present situation for current needs happens differently with small children and with adults. In an adult, this understanding may present ethical problems with their ramifications. The potential of the objectives in a situation is not always clear in relation to someone's actual needs. Therefore, clarification of the potential of the elements in the present situation for the current needs of the learner can be seen at the very beginning of all human actions.

Each of these four components can turn into an independent area, with its particular significance. However, even being in a simple form and inseparable from each other, these four components are always present in orientation - in humans and in animals. Another thing is that for an animal, it is natural that objects possess useful potentials which an animal is already aware of. This is because an animal lives in the world of instinctive relations and a significant feature presents itself immediately as an unconditioned stimulus that evokes positive or negative attitudes to it. Hence, each of these complex four components can be identified in any orienting activity.

These four components are not only complex, but they are different too. To begin with, we would like to start with some simple ideas: the two main components in the managing aspects of orientation. These are always images of one kind or another (either it is an image of the present situation, or an image of the action plan, or an image of an action that is being executed that merges at some point with its plan, or an image that has a kind of scattered potential - something matters, but something does not matter, etc.). So these are images, different, but images. In addition, there are always actions that are performed in terms of these images. Well, let us say we make a visual estimation of the distance from ourselves to an objective. This is an action in terms of images, because we deal with perception, we do not do anything with hands; if we move our eyes, which is only of secondary importance, this does not represent the way we estimate the distance, because sometimes we do it even without moving our eyes at all. Hence, we perform an action: estimating the distance in the visible field, but without performing material actions. This is an ideal action of which there are many, including those that are performed in mind. There are many other activities that are carried out by us on the ideal plane either in terms of perception, or mentally, but, anyway, these are ideal actions. They differ in purposes, but they are all defined as ideal actions.

So, we have two main components of any orienting activity - these are images that represent the reality around us (images as such, with their potential, as a plan or as a real ongoing process), and then, the actions that we perform in terms of these images which are ideal too. Therefore, our task today is narrowed to the two main elements of orientation: images and ideal actions in terms of images. Having identified the two main components, the question is: which of them do we start with?

Any ideal action takes place in terms of images and therefore, it presupposes the existence of these images. On the other hand, images themselves are the products of the actions, and the actions that are not only ideal, but above all in their original form - real actions with objects, which are later presented for us as images. So, images themselves are the products of the actions with objects represented in images. Strictly speaking, these are two inseparable elements, but we would like to start with the one that we could use as a clue in our study of these complex phenomena. That is why we choose the development of ideal actions as a starting point of our investigation and, as you see, images are needed, in fact, to enable us to perform these actions; while images themselves are the products of actions (material and ideal).

So we start with the formation of ideal actions. In this endeavour, we cannot begin as if we were the first humans on earth, because there are certain premises we need to start with. *The first premise* of the formation of an ideal field in general, and specifically the formation of an ideal action, is the famous statement by Marx in his foreword to the second edition of the first volume of "Capital". Marx contrasts his method to the method of Hegel, saying that for Hegel ideal is a demiurge, the initial motor of the entire universe, and for him, for Marx (his exact words), "*the ideal is nothing else but the material transferred to the human head and transformed in it*". Let us consider this statement as a starting point.

Based on this premise we can consider ideal actions, which we produce in the field of perception, in terms of speech, or mind, as derived from external subjective, material actions, which are then transferred into a human head. During this transferring and further functioning in the human mind these actions undergo regular changes, becoming what we discover later as ideal actions.

These ideal actions are nothing more than real, substantive, external actions in their origin, content and primary function. But for us it is very important (and here comes the second premise), that these material actions should be also created. We say that ideal actions derive from material actions, which do not appear by themselves in their final form, but have to be created. Hence, *the second premise*, is to find or create a material action, which an ideal action could be derived from. This is a very difficult task, because usually we get so separated from the material in our mental activity, that we cannot find its roots, its origin. This is a particular challenge. Every time we would like to investigate the formation of an action, we need to find an appropriate material action, create this action in this form, and then transfer it to the human head, and transform it into an ideal action.

¹ Galperin gives more details on the scheme later in the lecture.

The third premise is that not all actions can be transferred to the ideal or mental plane. Well, let's say, such actions as you are busy with now, writing. Your writing remains on the paper: if you do not write, there will not be any notes. So, writing, in its executive part, is an external action. It has its orienting part which is found with children who are learning to write and then gets reduced and transfers to the internal plane. The same happens, for example, when you learn a foreign language. In order to construct a proper phrase or a sentence, you have to get a detailed orientation to the relevant parts of grammar, phonetics, lexicology, and then, when you master this language, it seems that you just speak it. So, the speech as an external (oral or written) action remains external, while its orienting part undergoes changes, is transferred to the internal plane and is transformed there. Not every action can be transferred to the mental plane. There is a very wide range of what are traditionally called motor skills, which remain in the external field, in the field of material objects, while their orienting part transfers to the internal plane. On the other hand, there are actions that can be entirely transferred to the mental plane and they can be performed on both the external and internal planes. Imagine that you are studying maths. You can perform mathematical calculations in writing, externally, and you can learn to execute them in your head. When you perform calculations mentally, the whole action is transferred to the internal plane. For research purposes, for instance, it is very advantageous to select the forms of activities that can be completely transferred to the internal, mental plane. I would like to emphasise that this is not just an ideal plane, but a mental plane, because not every ideal plane is internal and mental. For example, the field of perception. Perception is a psychological concept, however it is different from imagination, although it belongs to the ideal plane. This plane has one very important feature that has been identified in psychology: the subject himself separates this ideal plane from the plane of external things.

There are very many phenomena that are considered to be on the internal plane, but psychologically, strictly speaking, they refer to the external plane: for example, hallucinations. A hallucinating person believes that what he hears, sees or feels really exists. The same false sense of reality of what is perceived differentiates hallucinations from illusions. Therefore, a psychological plane - is an external plane! Hallucinations might be an indicator of poor health, but psychologically these perceptions refer to an external plane. Importantly, it is not what someone sees or hears, but that someone has mixed reality and the internal plane. There are some very beautiful (in the psychiatric sense "beautiful") hallucinations described by a famous Russian psychiatrist Kandinsky and, thus, called "Kandinsky hallucinations". They are very bright, and projected to the outside world, but one is absolutely sure that these are hallucinations, not reality. This means that a person's confidence in objectivity does not correspond to the vividness of the images. One might see a very vivid picture and be sure that this is one's imagination. Alternatively, psychiatric patients may listen carefully to some voices, which they cannot make out, but they are completely sure that these are real voices and someone is whispering something to them, usually something unpleasant. What is important is that the patient is convinced about the existence of these voices. He might not make out words, but the person has no doubts that these voices are real.

What I have just described constitutes the difference between the mental plane that belongs to an individual and the ideal plane that might comprise a person's reflections and perceptions.

Based on this difference between the mental and ideal plane, we will start investigating the actions that can be completely transferred to the internal, mental plane. But here we need to establish a few preliminary conditions; otherwise we can easily slip into the situation in which psychology and pedagogy have found themselves. We cannot, if we are researchers (if we are teachers and we have no time for research, this is another matter) behave in the same way as people who educate others with regard to creating mental actions. We cannot just explain something. Imagine that we explain an arithmetic rule of addition or the identification of sounds in a word to a child. These are basic things that are taught in school. How is this usually done? A child gets an explanation of the action itself. Sometimes a teacher shows how this should be done. Then the most capable child is asked to repeat what has been explained and he does so. Then the teacher assigns homework to practise undertaking the action. When the children are back in school, they are tested to ascertain if they have mastered this action. So, the whole process of learning takes place, in fact, beyond any control and it happens as if by itself. We just evaluate skills demonstrated by students by awarding grades. One student is performing well, another very well, the third is mediocre, and very many perform, in fact, poorly. If students still cannot perform the action, we repeat the instructions, ask students to practise more, but if someone still cannot do it, we say, removing all the responsibility from us that he "lacks some cells in his head" and we blame the child.

We are not going to discuss how this happens in detail. What is important is that the whole process of learning remains "behind a wall" and is not visible for us. In this case there is nothing to study and nothing to research. Of course, this approach can be used in educational practice, if practitioners cannot offer anything better they cannot be blamed for that. However, if we would like to study this learning process, we must reveal it, but how? To start with, we cannot limit ourselves to observing only what actually happens, it may then seem that the learning process gets started and then proceeds as if by itself and we evaluate only the final outcome. I do not believe this is the right way to go about things, but how can we manage and control the whole process of learning?

Firstly, we must accurately identify the qualities of the future learning process. For example, if we would like to teach a child how to break down words into sounds, it is necessary to identify the requirements this skill has to meet: should a child be able to break down words in fast speech, a speech of another person, whether he should do it out loud or learn to perform it silently, and so on. When we design for an action, and above all if this action is going to be assessed, we should identify the qualities of this future action, which will be used later for the assessment. What is more important is that an action always leads to some result or an outcome which should be achieved under certain conditions. If you would like to examine how students learn in a planned activity, you need to describe in detail the conditions and the way the activity should be carried out and identify its expected outcome. Hence, you should describe in detail the qualities of the action you are designing for.

Secondly, you have to select the system of conditions to ensure the desired properties of the designed action. This does not mean you should only highlight what is present already. Very often these conditions must be created and likewise, you should also identify potential pitfalls in the designed action. This is, actually, just the opposite of what an ordinary teacher normally does. Usually a

teacher explains the task, emphasises why it is important, and shows how to complete or solve the task. Then he asks students to learn everything that needs to be learnt by solving other tasks; however, how the students learn remains out of the sight of the teacher. The teacher just assesses the final outcome. I would like to suggest another approach: not to delegate our duties to students, but to find a system of conditions under which students *cannot help mastering the action and, in doing so, learn how to complete/solve other tasks*. Above all, the action needs to possess the desired properties that have been identified previously and hence, we have to employ a rigid system of conditions under which students will definitely master the action with its predetermined properties.

Yesterday, I read a study. The author reported that using a system of certain conditions, even children with learning difficulties can learn things which they would never be able to learn under usual teaching. A task should be broken down into such small units of the kind, that we would never use for ordinary children, because such small steps represent something very painful and disturbing, as any division hinders and delays learning. So, what is negative for an ordinary child, can be beneficial for a child with learning difficulties. It turns out that if you break down an action into smaller chunks, then even a child with disabilities can master this action. However, there is another very interesting aspect of this matter, but I will tell you about it later. Hence, it is important that we do not just set a task for a learner by saying: I have explained everything to you and now you have to solve it yourself; but instead we select a set or a system of certain conditions that would assist the child in solving this task.

This system of conditions is labelled the phases of mental development and ensures that the action being designed for will possess the predetermined qualities. This is a very narrow label, however. This system of conditions includes three large, though interrelated and intertwined, subsystems: the first – is a subsystem of conditions necessary to design an action; the second – is a subsystem of conditions necessary for the acquisition of this action and its desired qualities; and the third – is a subsystem, so-to-say, “transferring” the action from the external plane into the human mind.

Let us explore each of these subsystems. The first – is a subsystem of the conditions necessary to design a particular action. When identifying these conditions, we have to recognise that every action is characterised by what it produces - its product or outcome. All actions have an outcome; even those that seemingly do not have one. For example, gymnastic movements, what product or outcome do they have? The outcome is a particular form of an action, which is desired to be achieved and which, as you know, can be achieved only with great effort, because it is one thing - just to perform a movement, and another - to perform the movement with its predefined qualities. Of course, you are aware that this requires considerable effort and those who engage in sports or gymnastics know how difficult it is to perform floor exercises.

So, every action has its own outcome and is characterised by this particular outcome. An identification of the final outcome with its distinctive characteristics is the first point to be considered when designing for an action. For example, if you would like to design a writing activity, then you will need to teach explicitly how to write fast and clearly. Well, perhaps most of the students in this room do write more or less fast, but whether they write clearly - this is very doubtful.

As I have already said, the starting point in the design of an activity is identification of its final product with its desired characteristics. Usually these characteristics are: the size, the speed of execution, etc. The second point is that we identify the units of this product in the order they need to be constructed, in other words we specify the parts of this product in the order of their execution. This order may not match the sequence in which these units appear in the final product or outcome, however, you need to specify those that make up the final product in the order of their execution, and each unit should have its specific characteristics. When you have identified the characteristics of all the units to be created, then, in the third step you specify the operations necessary to create each unit, which sometimes may require several operations, and you specify them: i) in the order of their performance and ii) the desired qualities of these operations in terms of speed, sequence, size, etc. (We will talk about this in detail later.)

Hence, it is necessary to introduce the order of all the operations that constitute each unit. Of course, this should include the initial material you are working with or the starting point. After all, an action will lead to the final product, which comes from the existing initial material. The characteristics of the initial material of an action are also important and they are included in the same description.

What then follows is the reference to the tools learners can use. Almost all human actions are performed with various tools. These tools can be natural in origin, for example, their own bodies, or they may be artificial. Even when writing, you use a pen, which has to meet certain requirements (often we are unhappy with the quality of pens), paper, which also has to be of certain quality, etc. Hence, there are tools that we use, but there are also other tools. For example, when we study a foreign language, we have to learn to pronounce its sounds correctly with the help of another natural tool - the larynx. We force our poor larynx to speak the way it has not been used to from childhood - in a foreign language, based on other principles of intonation. You know this is one of the most difficult tasks – to learn the proper intonation, the phonetics of a foreign language; however, this is absolutely necessary. In the descriptions of how to perform physical exercises it is pointed out clearly how to teach our limbs to move, not the way we move them in everyday life: for instance, sometimes how some people walk looks awful. In the military, soldiers are taught different types of marching or steps, and not only in the military, but in ballet schools too. If you at some point meet a person who can walk properly: you will envy this person and will also try to walk, not anyhow, but in a way that means that you would be looked at and admired. Hence, everything needs to be learnt, and we must teach our own body movements to meet these specific requirements.

Tools can be of all sorts. If you take the production of material things, then these tools are machines, cutting, assisting, measuring instruments - all these instruments should be linked into a single, interconnected system.

There is another very important point, which I introduced only in a general, very descriptive way and now I would like to present it as a separate part of the system. A learner, and we consider a learner any person who is learning, if he is an academic – he is still a learner, if he is to learn something, he has to be presented with the overview of the whole activity. Previously, we said that the fourth component item of the scheme, which we label the scheme of the orienting basis of an action, is the representation of the scheme of action as a whole. Consequently, a person has to follow this scheme when he begins to perform a new action. Now we can clearly

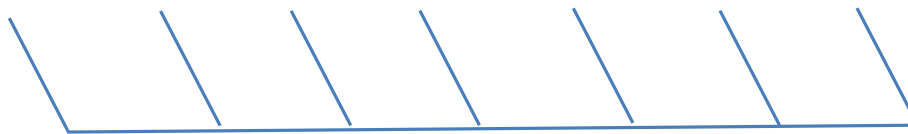

Fig. 10A. The foundation of the church building.

specify this last component as *an operational scheme of thinking*. This is a very important point, which shows the difference between a machine and human approach to an action: a machine does not need this operational scheme of thinking, everything else can be supplied to the machine, but not this scheme. This is a general scheme of action. If the system of instructions is very difficult or when students have to act without any visible cues, then we need to offer the learner the general operational scheme of thinking in addition to a list of the order of operations to be performed.

Let me give you an example of one very beautiful operational scheme of thinking. The students in the 3rd–4th grades were taught to analyse the monuments of ancient Russian architecture (mostly churches). Generally, Orthodox Churches are complex buildings: they have a lot of different elements, they are characterised by different parameters, and there are different schools: Moscow, Vladimir, Novgorod, Kiev, etc. These schools have their own well-defined features. In addition, within each school, churches of different types were built: some of them - strictly monumental, others - solemn, and others - festive. There were churches, so-called, for home use, which were more intimate, etc. So, the students were to learn to distinguish which church belonged to which school according to clearly defined criteria. One of these criteria used in the analysis, was the structure of the churches. This structure was analysed, starting from the foundation (Fig. 10A).

Then the main box (Fig. 10B).

Then the roof (Fig. 10C).

Then the drum (Fig. 10D).

Then comes the head that finishes everything (Figs. 10F and 10G).

Then the doors (Fig. 10H).

Then the windows (Fig. 10K).

Then other auxiliary buildings (Fig. 10L).

In addition, each of these elements has a number of specific items. For example, the foundation: which materials it was built from and according to which plan, etc. Each of these elements contains 6–7 such items. For instance, the main box could be cubic, rectangular, hexagonal, or octagonal. All this requires a detailed analysis. It turned out that when the children were given a card with the scheme, this card appeared to be very complicated (Table 10.1):

The children could use this scheme by moving from one item to the next one, analysing and drawing conclusions about the type of construction. However, it was very difficult to transfer such a complex scheme to a mental plane. As soon this scheme was taken away from the children, they appeared to be helpless. Meanwhile to teach - means to develop the capacity with learners to analyse independently, on their own, rather than using this card. In order to do so, children should be given an operative scheme which surprises them because of its emptiness; but also because of its usefulness (Fig. 10M).

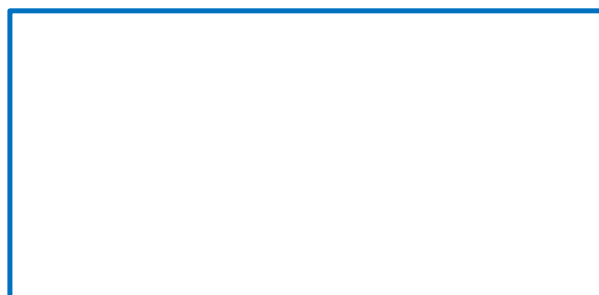

Fig. 10B. The main box of the church building.



Fig. 10C. The roof of the church building.



Fig. 10D. The drum of the church building.

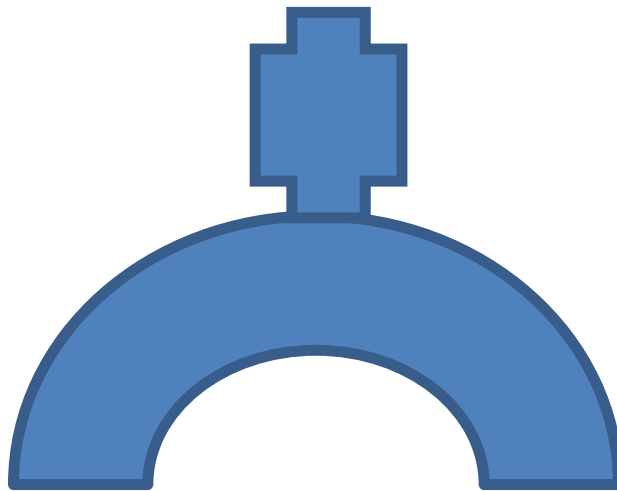

Fig. 10F. The head of the church building.

The analysis proceeds from the foundation of the church to the box from the box to the roof, from the roof to the drum from the drum to the head, and then it turns to the door, then to the windows, and then to other buildings. So, in addition to a huge list, another scheme is needed. But what does it actually add? After all, it is empty. This scheme provides the general division of the object into its elements and also the procedure for the analysis, which guides the analysis of the object. This is a very interesting thing. You see, this is exactly what a machine does not need because it follows the uploaded scheme or program and produces an answer. A machine does not need this special operative scheme. Schemes of this general nature are operative and have special relation to the way we learn. Earlier we used to think if you have some knowledge – good, if you do not - bad. It may happen that you have knowledge, but may not be able to operate with it, if you do not have an operational scheme which forms a so-called meta-understanding of how knowledge is created within a particular subject.

This is what the last point of the scheme of the orienting basis of an action should be (we call it a scheme because the action has not happened yet and when the action happens, then the scheme will turn into the orienting basis of the action). In addition to this scheme, there should be an operational scheme of thinking regarding what a person should do. If the scheme of the operating basis of the action is relatively simple, if the movement from one item to another is enough to perform the action, then we do not need to identify an operational scheme as a separate item, but psychologically this operational scheme is still being identified by learners. However, if the scheme of the orienting basis is complex, then the operational scheme has to be introduced separately.

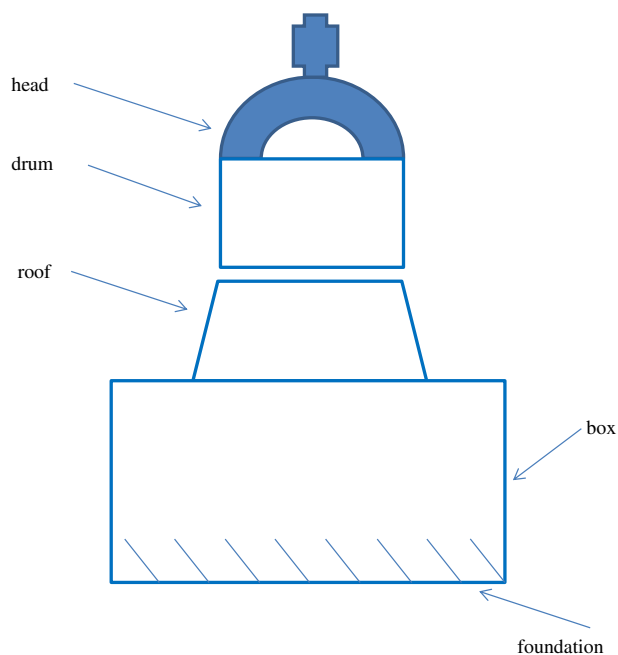

Fig. 10G. The structure of the church building.

What also seems important is that the division of the action into individual steps should take into account how well the learner is prepared for these steps: if a learner is well-prepared, then the steps will be larger; and if a learner is less prepared, the steps should be smaller, fragmented. There is, of course, a limit for this fragmentation; because if learning is divided into very small chunks then it is always necessary to make sure that the preliminary knowledge and skills have been mastered by students. The prerequisite for mastering new knowledge is very important for a student who, for example, is not able to learn even the simplest component of the new knowledge on his own. Therefore, it is important to distinguish between the general division of the desired action and the student's individual and psychological needs. Equally, it is necessary to distinguish between the units of the action and the individual steps of a student in this scheme. A learner starts with the steps he can do himself and then the steps should increase, although the general structure of the action remains the same. After a while the learner is able to proceed in bigger steps, which is one of the most important tasks - to increase the size of the steps of the action while it is being performed. In the end, the action turns into one continuous stream, into one single step. Sometimes it happens that individual actions merge and form steps that exceed the size of these individual actions. Objectively, they are a chain of actions, but for a learner they are merged into one continuous stream. This should be pointed out very clearly, because one thing is what you need to master, and another thing is that while mastering it you modify the way you perform the action, and, accordingly the way this action appears to you - as integral or divided.

There is one very characteristic signal that indicates whether the scheme of the orienting basis of an action is complete. After all, you can create this scheme based on your own premises, but a student, following the outline of your scheme may not always perform the action. Who is to blame in this case? You! If a learner has all the necessary prerequisites and if you have created the complete scheme, then the indicator of this is a paradoxical situation that, following the outline of this scheme, a student who has been unable to perform the action without the scheme, can perform it correctly from the first attempt and repeat this performance correctly every time afterwards. A learner is not able to perform the action without the scheme that you have created, but using it, he performs the action step-by-step. When the scheme has been constructed properly, then the student will inevitably achieve the desired result. This circumstance is somewhat paradoxical at first glance, but it is absolutely clear that a learner, who was previously unable to perform the action, by following the scheme of orientation, now performs the action correctly from the first attempt and every time afterwards. If this is the case, the learner's performance indicates you that you have created a plan of action correctly. However, if a learner follows your plan (if he gets distracted, this should not be taken into account), performs one step after another and does not reach the desired result, this might indicate that the scheme is incomplete and you have missed something. Then look for these missing parts! This has always been very important to us and that is why we have spent over 20 years investigating possible scenarios, since it is not an easy thing to construct the scheme of the orienting basis of an action.

Therefore, the scheme of the orienting basis of an action is presented as a sequence of steps. It is often called an algorithm, but this is not an algorithm in its proper sense, not a mathematical algorithm. It is an algorithmic prescription, and it differs from the mathematical algorithm that a machine follows without any understanding. It is quite the opposite. You always make a prescription in such a way that it would be understood by a learner. This can be a very small prescription, for example for the child with learning difficulties that I told you about previously, but it should be oriented towards the child's understanding because, even within a very short operation, the child should be able to manage his action on his own. An action does not happen by itself, it has to be managed.

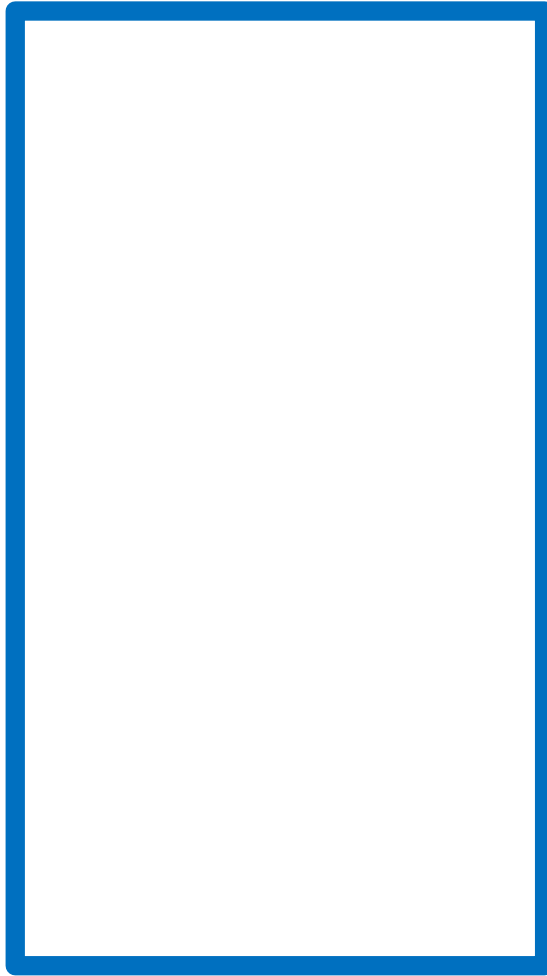

Fig. 10H. The doors of the church building.

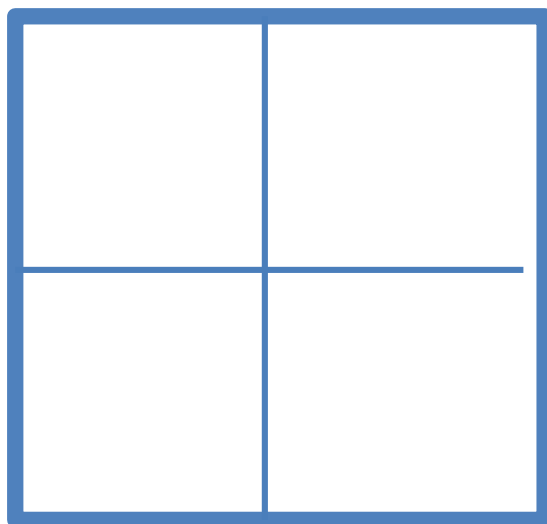

Fig. 10K. The windows of the church building.

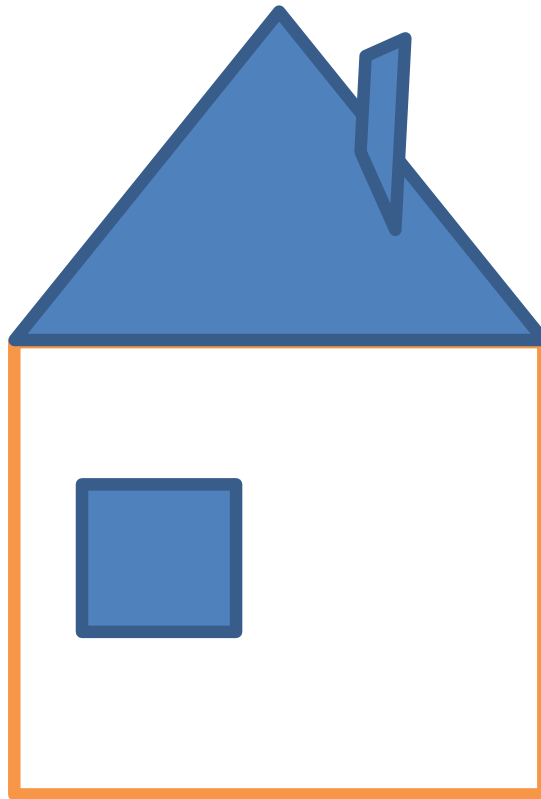

Fig. 10L. Other auxiliary buildings.

Table 10.1
The scheme for the analysis of church buildings.

Main elements	Points
Foundation	1. ____ 2. ____ 3. ____
Box	1. ____ 2. ____ 3. ____
Roof	1. ____ 2. ____ 3. ____
Drum	1. ____ 2. ____ 3. ____
Head	1. ____ 2. ____ 3. ____
Windows	1. ____ 2. ____ 3. ____
Other buildings	1. ____ 2. ____ 3. ____

So, contrary to what is required for the computer, we, from the very beginning, rely on the learner's understanding of the element or a step of the action that is being performed. In addition, there are also the characteristics of the product, the characteristics of its components and the characteristics of the existing material. A machine does not need any information about these features, but a person does. This operational scheme is always needed for a person, although it is not always presented as an individual resource, but psychologically it accompanies any action. A person will always identify it himself, or the scheme can be supplied to the learner, which will certainly make managing the task and the action in general easier. This is *the first subsystem* - the subsystem that facilitates

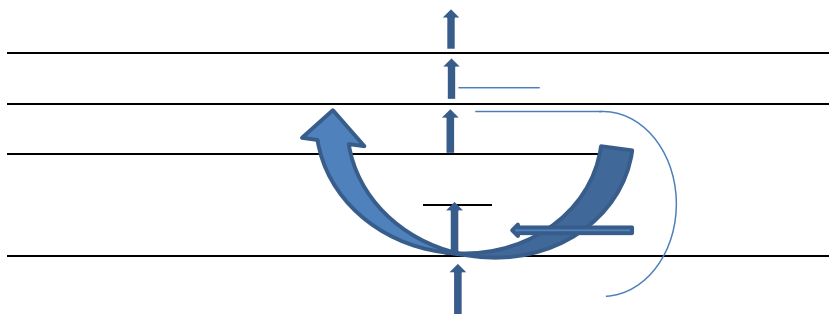

Fig. 10M. The operative scheme of thinking.

the construction or formation of a new action.

The second subsystem - is a subsystem that facilitates the acquisition of the desired properties of the action. We have come to the point when a learner is able to perform a new action, using the scheme of the orienting basis, but how do we ensure that the action acquires the properties we would like it to have? And actually what properties do we want this action to have? This is in the next lecture.